

2. Installing the Adapter Brackets

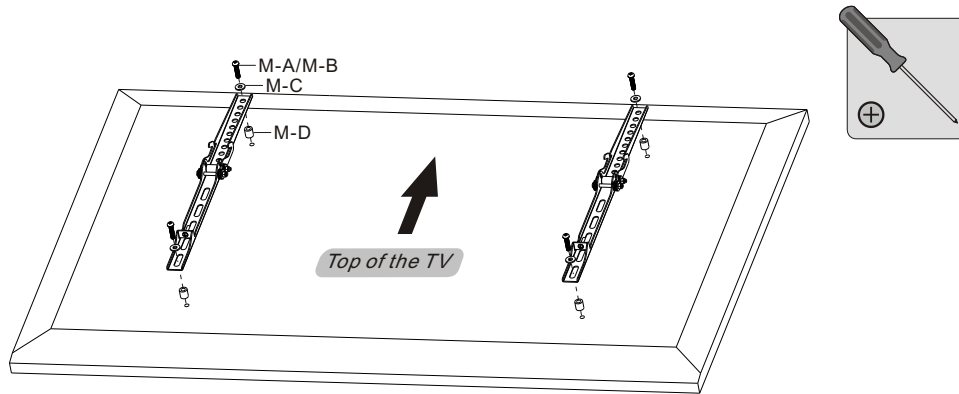

Note: Choose appropriate screws, washers and spacers (if necessary) according to the type of screen.

- Position the adapter brackets as close as possible to the center of the TV.
- Screw the adapter brackets onto the TV.

! Tighten all screws but do not over tighten.

3. Hanging the TV onto the Wall Plate

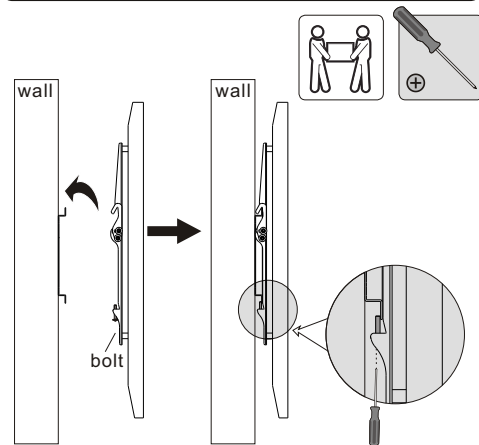

Tighten the bottom bolts to secure the adapter brackets to the wall plate.

4. Adjustment

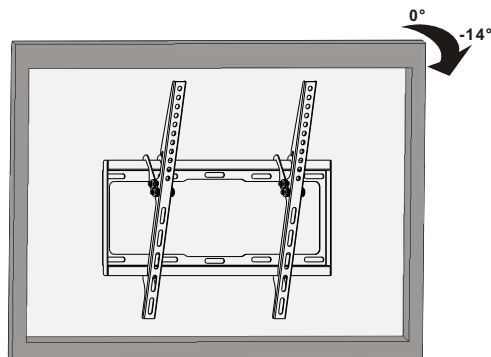

Pull from the top of TV to obtain a desired angle.

Maintenance

- Check that the bracket is secure and safe to use at regular intervals(at least every three months).
- Please contact your dealer if you have any questions.

Tilting Wall Mount

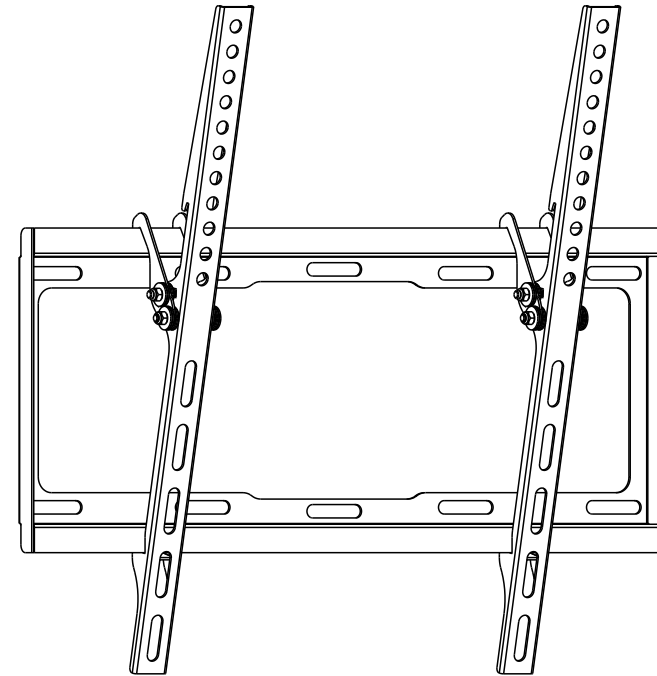

CAUTION: DO NOT EXCEED RATED LISTED WEIGHT CAPACITY. SERIOUS INJURY OR PROPERTY DAMAGE MAY OCCUR!

MT-433-BK



200x200/300x300
400x200/400x400
600x400



NOTE: Read the entire instruction manual before you start installation and assembly.

! WARNING

- This mounting bracket was designed to be installed and utilised **ONLY** as specified in this manual. Improper installation of this product may cause damage or serious injury.
- This product should only be installed by someone with good mechanical ability who has basic building experience and fully understands this manual.
- Make sure that the supporting surface will safely support the combined weight of the equipment and all attached hardware and components.
- If mounting to wood wall studs, make sure that mounting screws are anchored into the center of the studs. The use of a stud finder is highly recommended.
- Always use an assistant or mechanical lifting equipment to safely lift and position the equipment.
- Tighten screws firmly, but do not over tighten. Over tightening can cause damage to the items, This greatly reduces their holding power.
- This product is intended for indoor use only. Using this product outdoors could lead to product failure and personal injury.

Component Checklist

IMPORTANT: Ensure that you have received all parts according to the component checklist prior to installation. If any parts are missing or faulty, telephone your local distributor for a replacement.

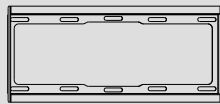

wall plate (x1)
A



adapter bracket (x2)
B

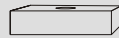

level (x1)
C

Package M



M6x30 (x4)
M-A



M8x30 (x4)
M-B



D8 washer (x4)
M-C



big spacer (x4)
M-D

Package W



ST6.3x55 (x4)
W-A

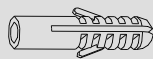

concrete anchor (x4)
W-B



D6 washer (x4)
W-C

1a. For Wood Stud Wall Mounting

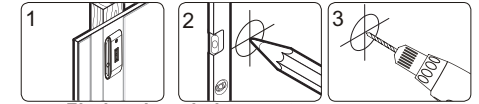
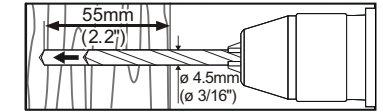
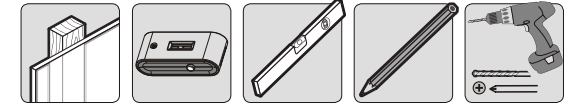
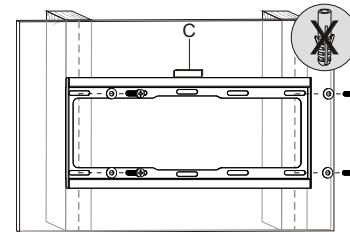
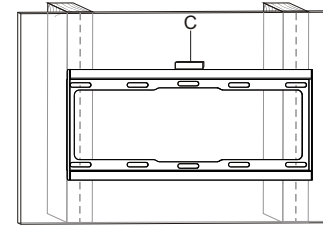

1 Find and mark the exact location of mounting holes

2 Drill pilot holes



3 Screw the wall plate onto the wall

! WARNING

- Make sure that mounting screws are anchored into the center of the studs. The use of a stud finder is highly recommended.
- Installers are responsible to provide hardware for other types of mounting situations.
- Installers must verify that the supporting surface will safely support the combined weight of the equipment and all attached hardware and components.

1b. Concrete Mounting

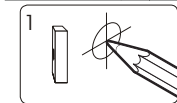
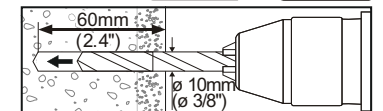
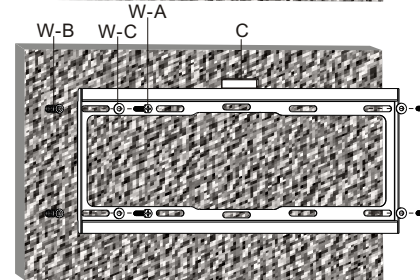
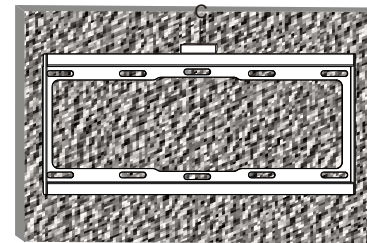

1 Mark the exact location of mounting holes

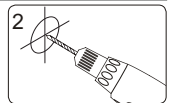

2 Drill pilot holes

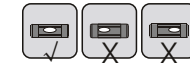

3 Screw the wall plate onto the wall

! WARNING

Installers must verify that the supporting surface will safely support the combined weight of the equipment and all attached hardware and components.